

Optional parts

All PEAK three models of parking lifts(407-P, 407-HP, 408-P, 408-HP, 409-HP) can be used with the below optional parts or components to bring flexible features.

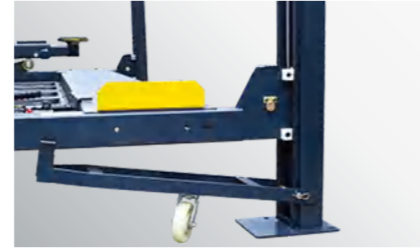

Optional Caster Kits help easily maneuver the parking lift. One set 4pcs
Kits No: 40801



Caster kits help easily maneuver the parking lift.



Optional Motor protective cover (with emergency stop switch)
Kit No.:40810

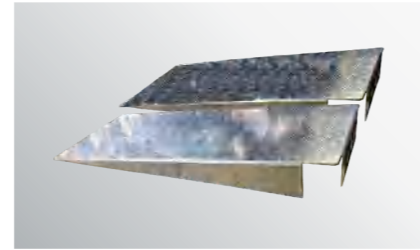

Optional extended aluminum alloy drive-in ramps.G.W:20KGset, length:1270mm.Kits No:40805

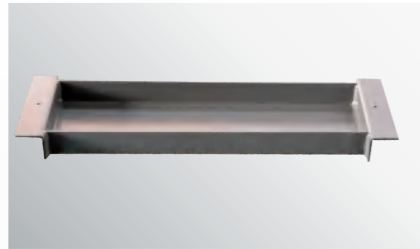

Optional Jack Tray for 407-P, 407-HP, 408-P, 408-HP. Kit No.:40808
Jack Tray for 409-HP. Kit No.:40809



Optional Drip Trays one set 4pcs . for 407-P, 407-HP, 408-P, 408-HP. Kit No.: 40806. Specifications 930*600mm for 409-HP, Kit No.: 40807. Specifications 1067*600mm



Jack for 407-P, 407-HP, 408-P, 408-HP
Sliding Jack J5H with hand pump, and 1.5"&2.5" extension adapters included
Capacity: 5000 Lbs.(2.2T)



Rolling Jack J6H for 409-HP
The rolling Jack J6H is come with hand pump and 1.5" & 2.5" extension adapters. This is the same rolling Jack use for our general service four post lifts. Capacity: 6000 Lbs.(2.8T)

PEAK
World-class lifts

PEAK 4-Post parking lifts are the professional design four post lifts for storage and general service.

These 4-post portable lifts are designed with internal safety locks system and superior quality than most of the storage 4-post lifts in the world.



**COMMERCIAL GRADE
4-POST PARKING LIFT**



Distributed By:

PEAK CORPORATION
<http://www.peaklift.cn>

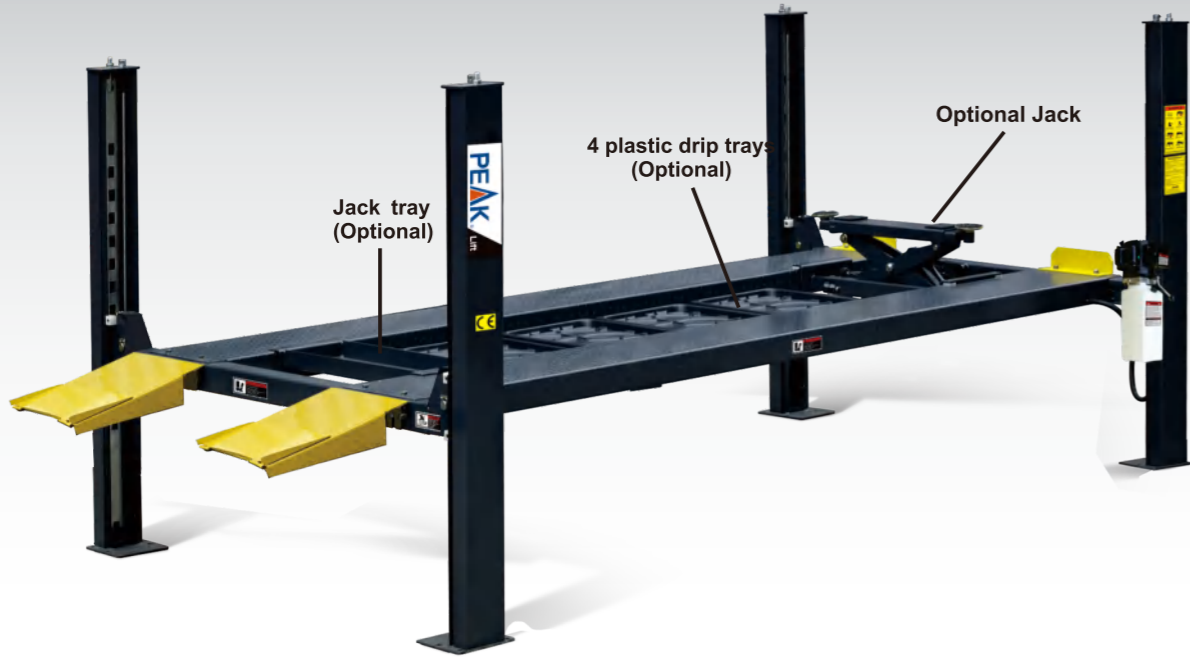

MODEL 407-P

The perfect parking lift for shops or home garage with limited floor space.

MODEL 407-HP

Commercial Grade 4-post Parking Lift for Car, Van and SUV. Similar to model 407-P, but higher. 407-HP is 330mm (13") higher than 407-P.

FEATURES

- 3000kg lifting capacity.
- PEAK exclusive hidden safety locks and manual single-point lock release.
- Double- shaped columns for increased strength.
- Non-slip platform.
- Optional parts: plastic drip trays, jack tray, caster kits.
- Flexible Design: power side column can be installed at any corner.

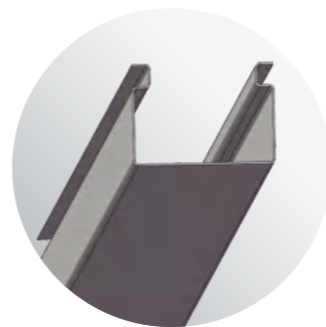

EXCLUSIVE FEATURE

Double- shape column

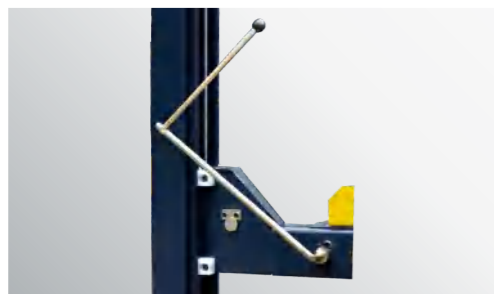

EXCLUSIVE FEATURE

Hidden locking device and manual single-point safety lock release

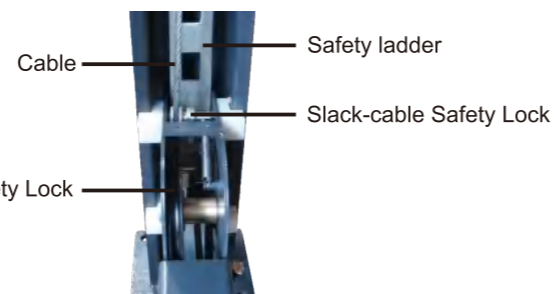

EXCLUSIVE FEATURE

Commercial double safety locks

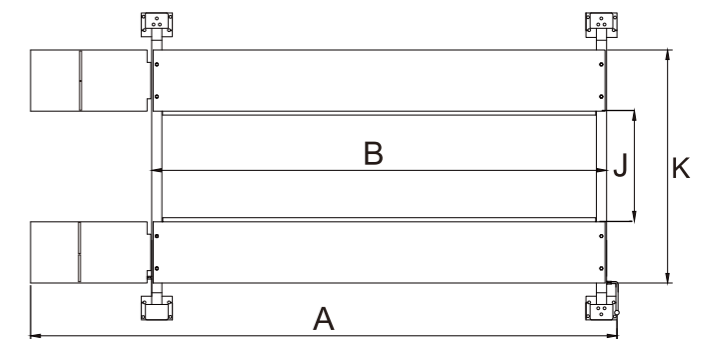
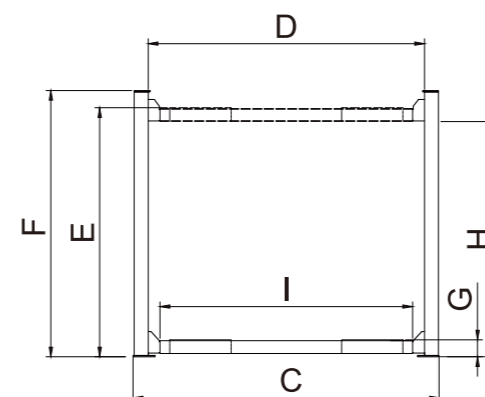

SPECIFICATIONS

Model	Lifting Capacity	Lifting Time	A	B	C	D	E		F	G	H		I	J	K	Gross Weight	Motor Power
			Overall Length (Inc.Ramps)	Outside edge of crossbeams	Overall Width	Width Between Posts	Max. Lifting height	Max locking height	Overall Height	Minimum Height	Max. Underneath Height	Max.Lock Underneath runway	Drive-Thru Clearance	Width Between Runways	Outside Edge of Runways		
407-P	3000kg	68S 31S	4720mm (185 7/8")	3700mm (145")	2409mm (94 7/8")	2167mm (85 3/8")	1872mm (73 3/4")	1792mm (70 9/16")	2105mm (82 7/8")	135mm (5 3/8")	1772mm (69 3/4")	1692mm (66 5/8")	1956mm (77")	940mm (37")	1890mm (74 3/8")	654kg (1,442lbs)	1.5HP110V 3.0HP220V
407-HP	3000kg	81S 37S	5008mm (197 1/8")	3987mm (157")	2409mm (94 7/8")	2167mm (85 3/8")	2202mm (86 3/4")	2122mm (83 9/16")	2455mm (96 5/8")	135mm (5 3/8")	2102mm (82 3/4")	2022mm (79 5/8")	1956mm (77")	940mm (37")	1890mm (74 3/8")	690kg (1,521lbs)	1.5HP110V 3.0HP220V



MODEL 408-P 408-HP

Professional Deluxe 4-post Parking Lifts one of the best 4-post parking lifts in the market.

FEATURES

- 3500kg(8,000 lbs) lifting capacity.
- PEAK exclusive hidden safety locks and manual single-point lock release.
- Double- shaped columns for increased strength.
- Non-slip platform.
- Optional parts: plastic drip trays, jack tray, caster kits.
- Flexible Design: power side column can be installed at any corner.

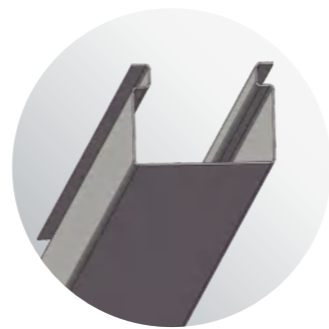

EXCLUSIVE FEATURE

Double- shape column

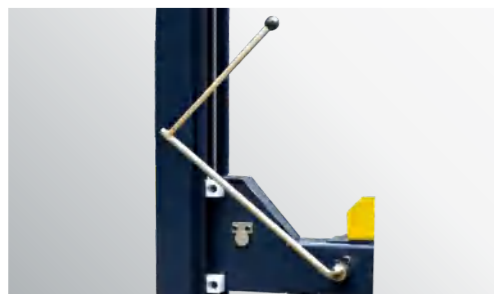

EXCLUSIVE FEATURE

Hidden locking device and manual single-point safety lock release

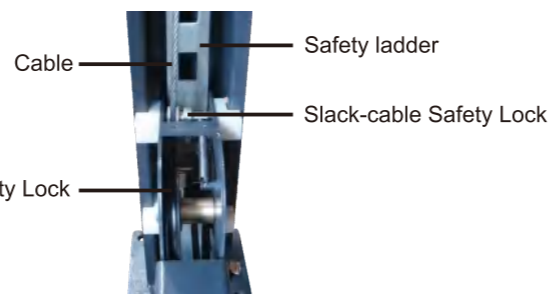

EXCLUSIVE FEATURE

Commercial double safety locks



MODEL 409-HP

A parking lift for full range vehicle including car, SUV and light truck. Similar to model 408-HP, but longer, wider and heavier.

FEATURES

- 4000kg(9,000 lbs) lifting capacity
- PEAK exclusive hidden safety lock and manual single-point release device
- Double- shape columns to increase the columns strength
- Commercial double safety locks
- Non-slip platform
- Four steel stops as standard configuration for more safety
- Flexible design as model 408-P

Power side column can be installed at any corner
220V or 110V single phase power unit
Designed portable, it can be moved easily by using the optional caster kits

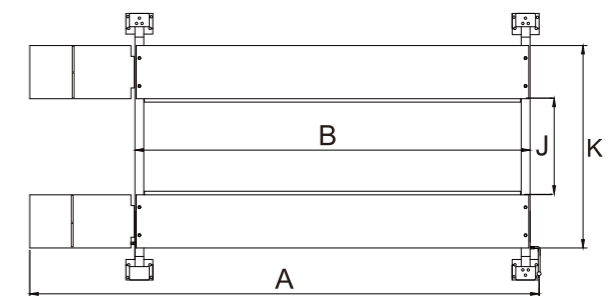
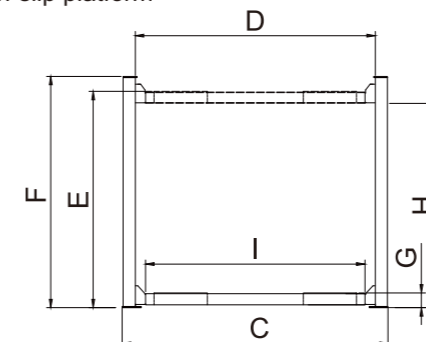

SPECIFICATIONS

Model	Lifting Capacity	Lifting Time	A	B	C	D	E	F	G	H	I	J	K	Gross Weight	Motor Power		
			Overall Length (Inc.Ramps)	Outside edge of crossbeams	Overall Width	Width Between Posts	Max. Lifting height	Max locking height	Overall Height	Minimum Height	Max. Underneath Height	Max.Lock Underneath runway	Drive-Thru Clearance			Width Between Runways	Outside Edge of Runways
408-P	3500kg (8,000lbs)	83S 40S	5265mm (207 1/4")	4238mm (166 7/8")	2604mm (102 1/2")	2358mm (92 7/8")	1872mm (73 3/4")	1792mm (70 9/16")	2105mm (82 7/8")	155mm (6 1/8")	1752mm (69")	1672mm (65 13/16")	2074mm (81 5/8")	940mm (37")	1890mm (74 3/8")	747kg (1,647lbs)	1.5HP/110V 3.0HP/220V
408-HP	3500kg (8,000lbs)	83S 46S	5265mm (207 1/4")	4238mm (166 7/8")	2604mm (102 1/2")	2358mm (92 7/8")	2227mm (87 3/4")	2147mm (84 1/2")	2455mm (96 5/8")	155mm (6 1/8")	2107mm (83")	2027mm (79 13/16")	2074mm (81 5/8")	940mm (37")	1890mm (74 3/8")	773kg (1,704lbs)	1.5HP/110V 3.0HP/220V
409-HP	4000kg (9,000lbs)	83S 57S	6049mm (238 1/8")	5022mm (197 3/4")	3026mm (119 1/8")	2780mm (109 7/16")	2227mm (87 3/4")	2147mm (84 1/2")	2455mm (96 5/8")	155mm (6 1/8")	2107mm (83")	2027mm (79 13/16")	2496mm (98 1/4")	1077mm (42 3/8")	2093mm (82 3/8")	881kg (1,942lbs)	1.5HP/110V 3.0HP/220V